

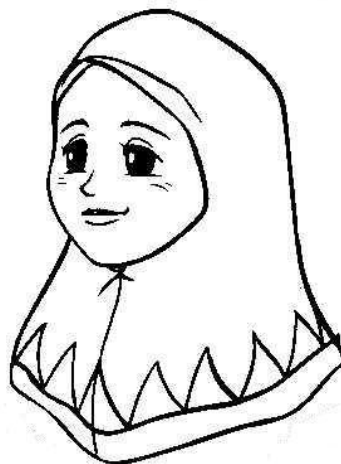







































# a



api

ani

Tulis huruf a dalam petak.

a	a					

Bulatkan huruf a.

a e a e  
b c b h  
a a

# b

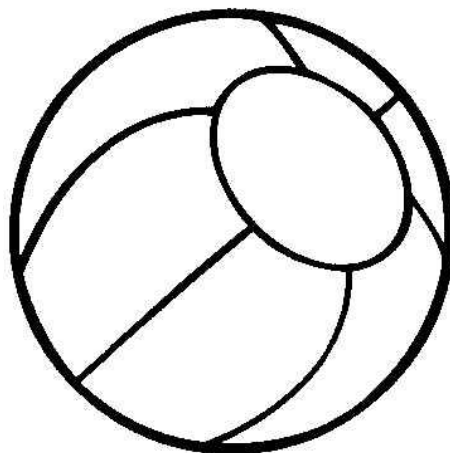
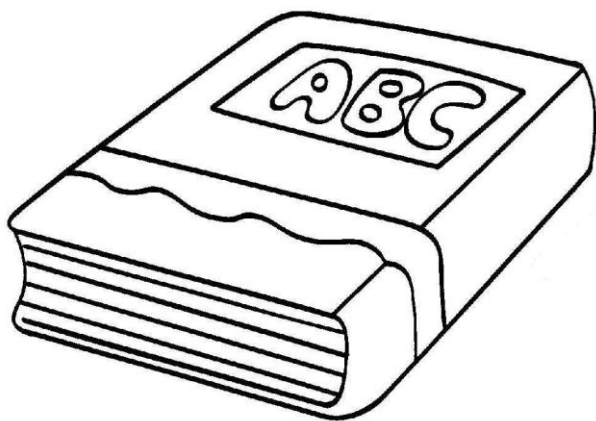

buku

bola

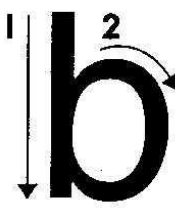
		b	b	b	b	b
		b	b	b	b	b
b	b	b	b	b	b	b
b	b	b	b	b	b	b
b	b	b	b	b	b	b
b	b	b	b	b	b	b

Tulis huruf b dalam petak.

b	b					

Padan huruf b dengan gambar yang betul.

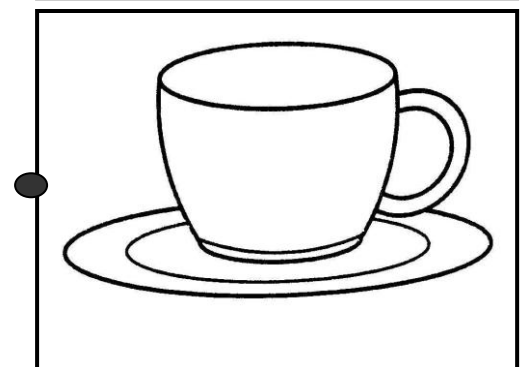
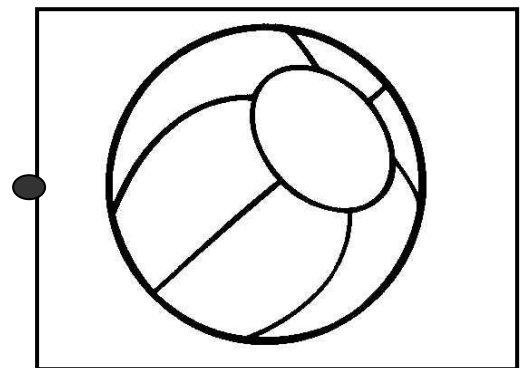
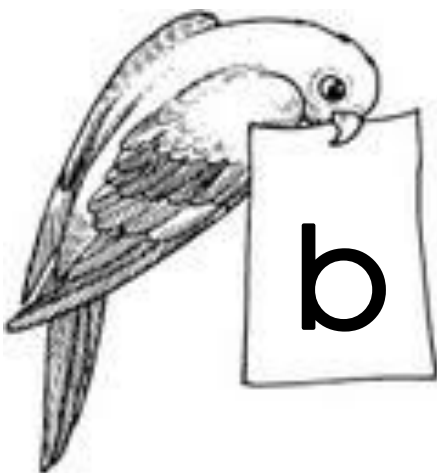

C

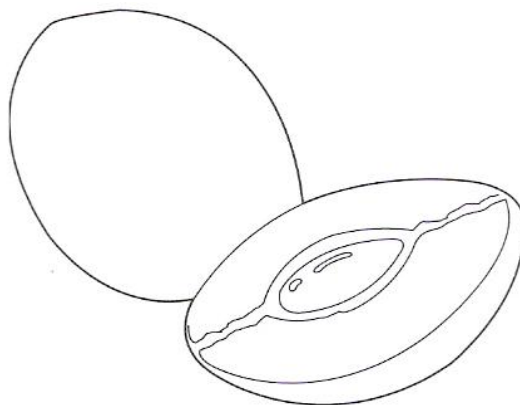

cili

ciku



Tulis huruf c dalam petak.

C	C					

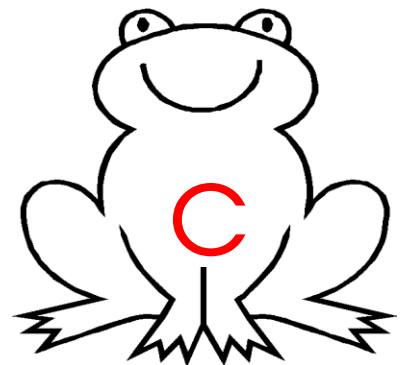
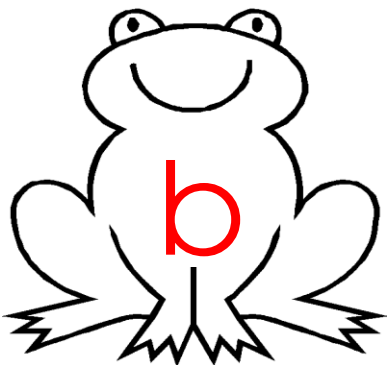
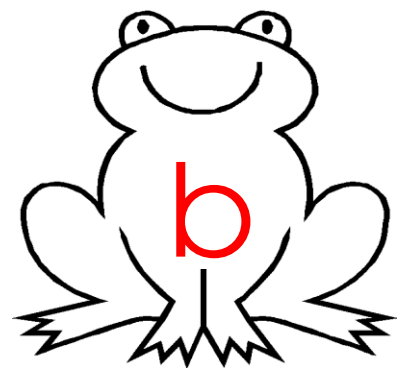
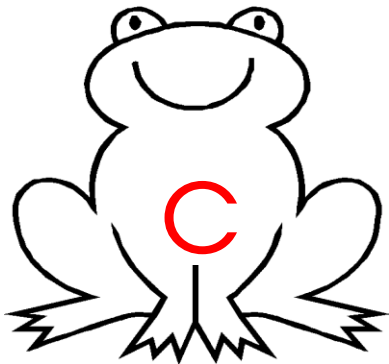
Padan huruf yang sama.

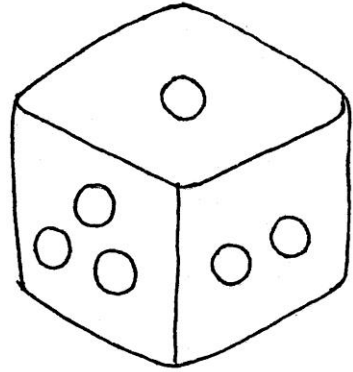
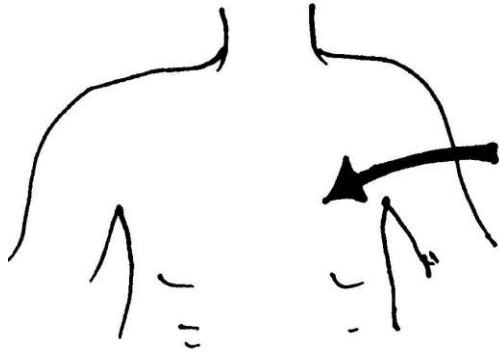

# d



dada

dadu

Tulis huruf d dalam petak.

d	d					

Tulis huruf yang betul.

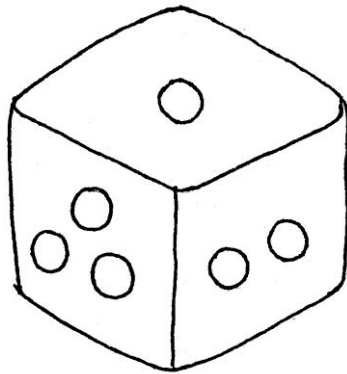

	a		u
--	---	--	---



e

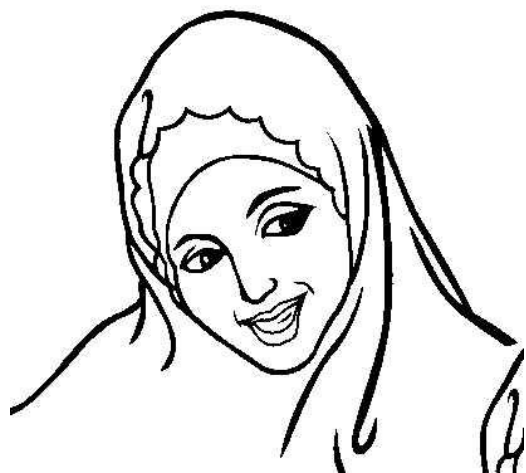

emak

ekor



Tulis huruf e dalam petak.

e	e					

Bulatkan huruf yang sesuai.

		
b	a	e

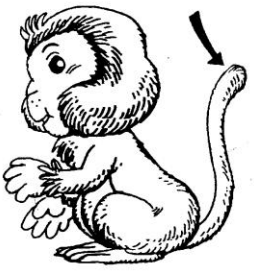
		
c	e	d

		
e	a	c

f

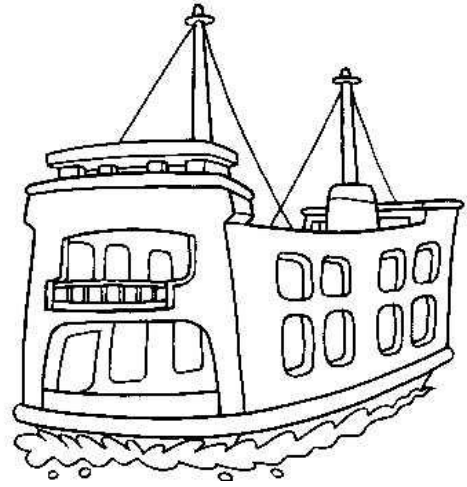
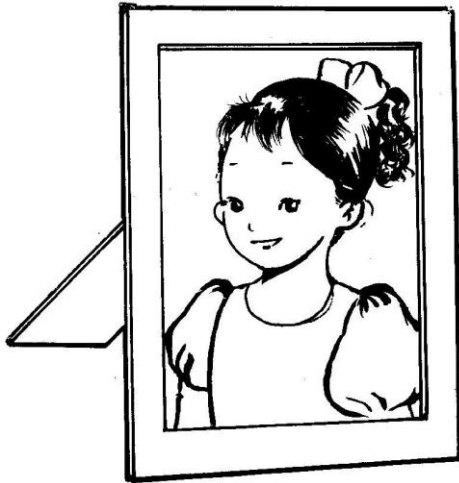

foto

feri

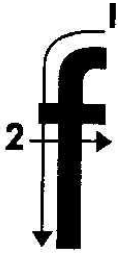
		f	f	f	f	f
		f	f	f	f	f
f	f	f	f	f	f	f
f	f	f	f	f	f	f
f	f	f	f	f	f	f
f	f	f	f	f	f	f

Tulis huruf f dalam petak.

f	f					

Padan huruf dengan gambar yang betul.

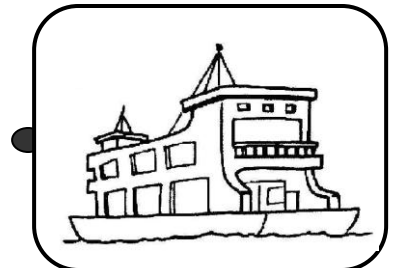
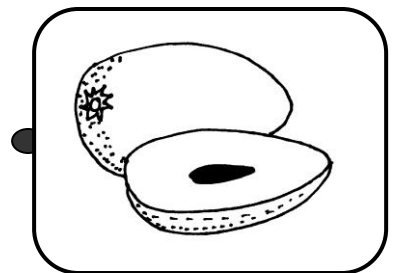
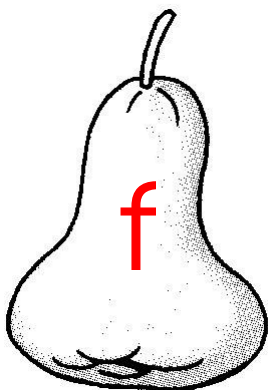

# g

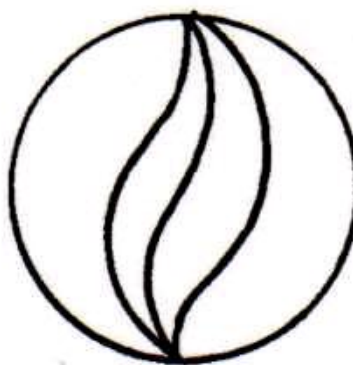

gigi

guli



Tulis huruf g dalam petak.

g	g					

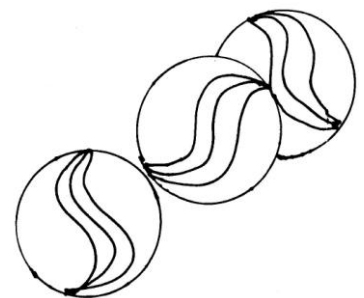
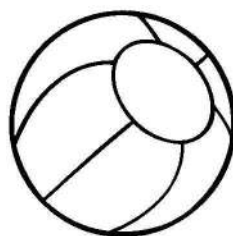
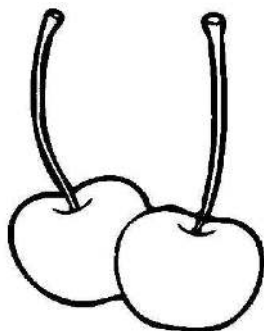
Bulatkan gambar yang mewakili huruf **g**.

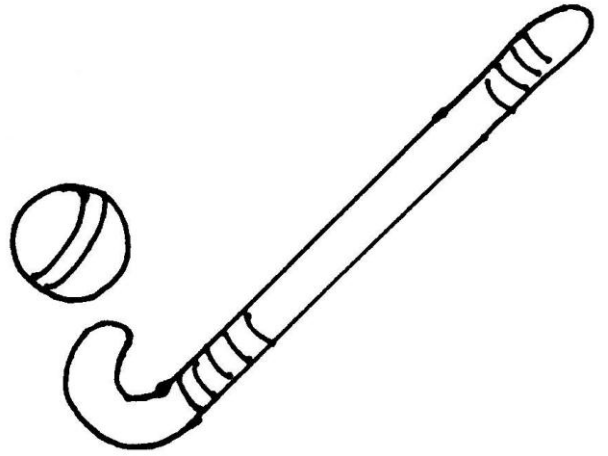
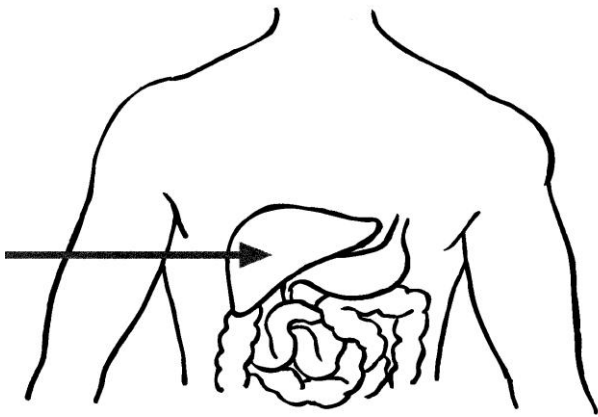

# h



hati

hoki

		h	h	h	h	h
		h	h	h	h	h
h	h	h	h	h	h	h
h	h	h	h	h	h	h
h	h	h	h	h	h	h
h	h	h	h	h	h	h

Tulis huruf h dalam petak.

h	h					

Warnakan huruf h.

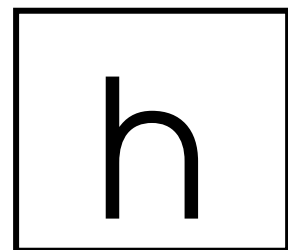
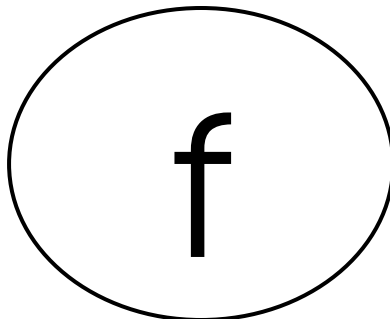
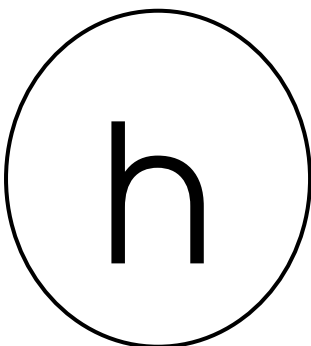
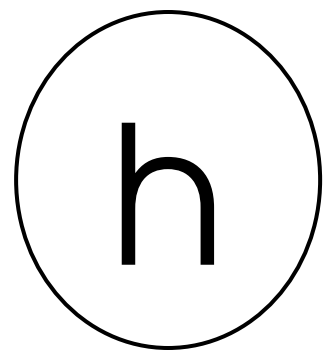
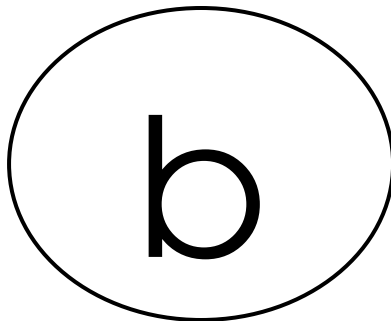
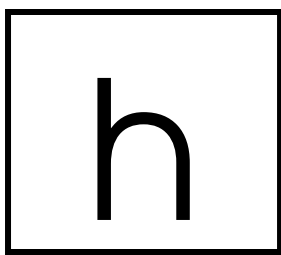



i

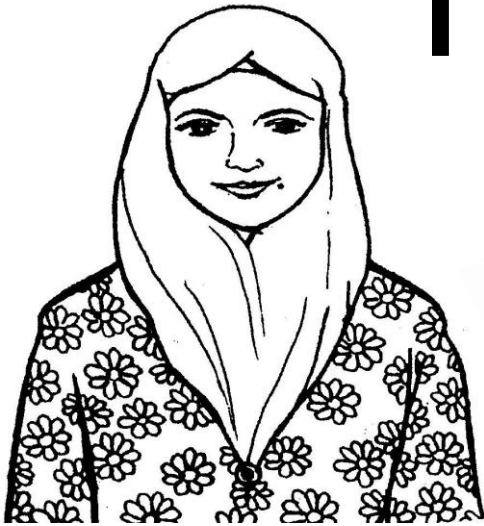

ibu

itu

		⦿ .....	⦿ .....	⦿ .....	⦿ .....	⦿ .....
		⦿ .....	⦿ .....	⦿ .....	⦿ .....	⦿ .....
⦿ .....	⦿ .....	⦿ .....	⦿ .....	⦿ .....	⦿ .....	⦿ .....
⦿ .....	⦿ .....	⦿ .....	⦿ .....	⦿ .....	⦿ .....	⦿ .....
⦿ .....	⦿ .....	⦿ .....	⦿ .....	⦿ .....	⦿ .....	⦿ .....

Tulis huruf i dalam petak.

i	i					

Warnakan kotak huruf yang sesuai dengan gambar.

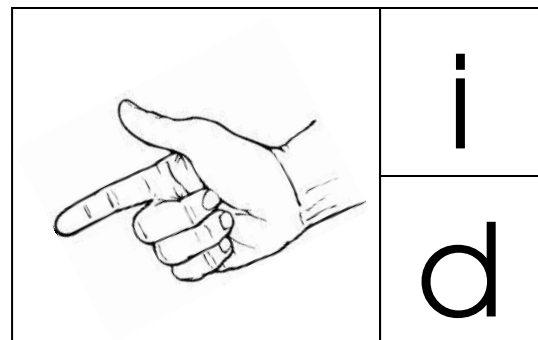
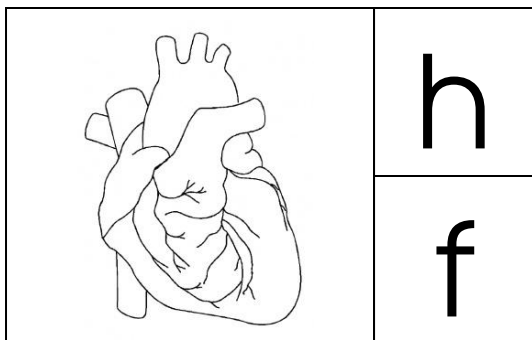
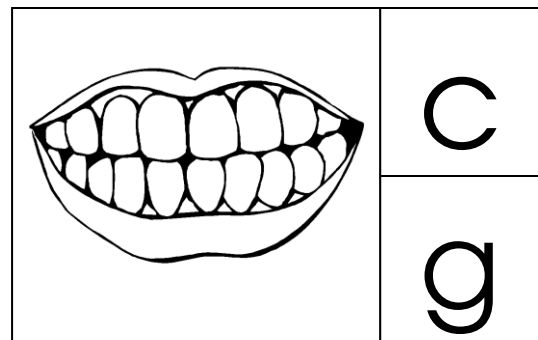
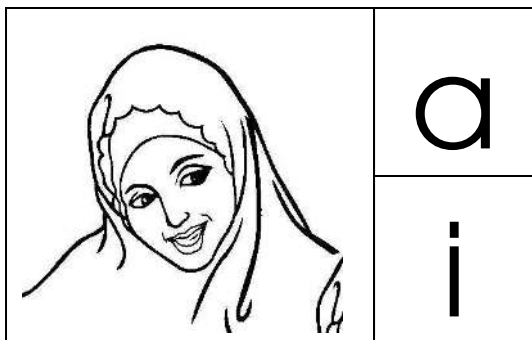



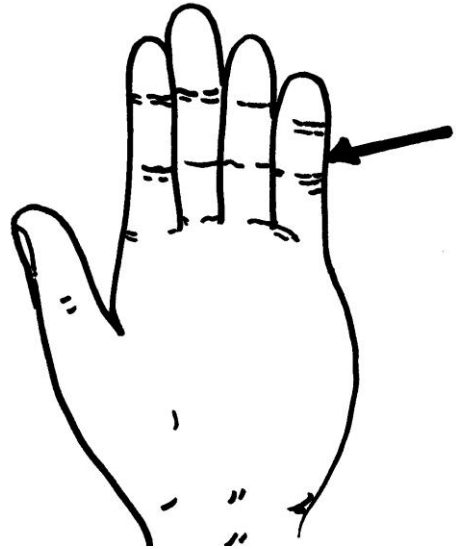
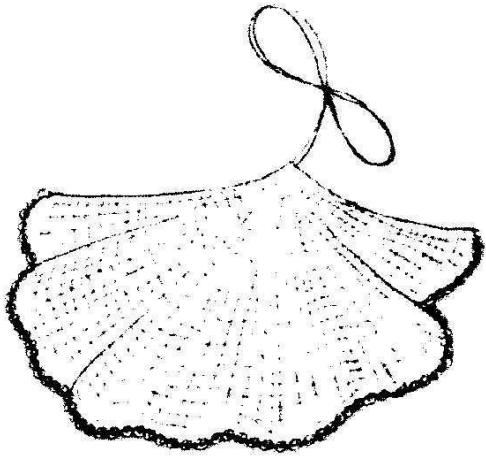







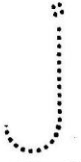

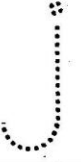

















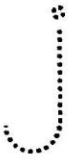





















j

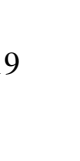

jala

jari

Tulis huruf j dalam petak.

j	j					

Bulatkan huruf j.

j h f c e  
d j j j a

# k

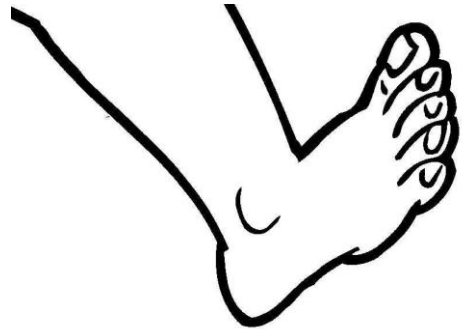

kuku

kaki

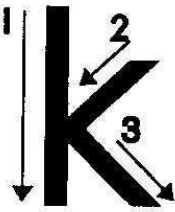
	k		k		k		k		k	
	k		k		k		k		k	
k	k	k	k	k	k	k	k	k	k	k
k	k	k	k	k	k	k	k	k	k	k
k	k	k	k	k	k	k	k	k	k	k
k	k	k	k	k	k	k	k	k	k	k

Tulis huruf k dalam petak.

k	k					

Tulis huruf yang sesuai pada gambar.

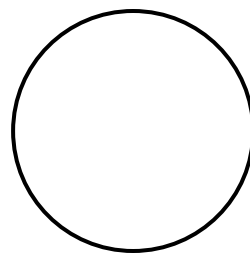
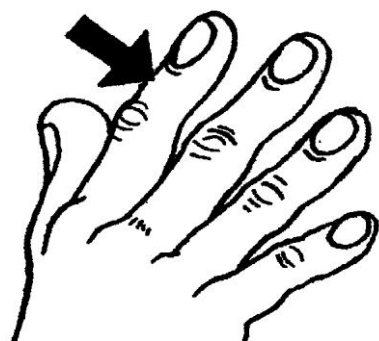
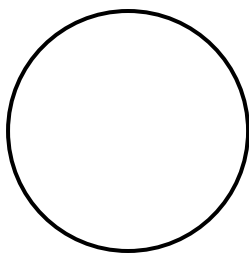
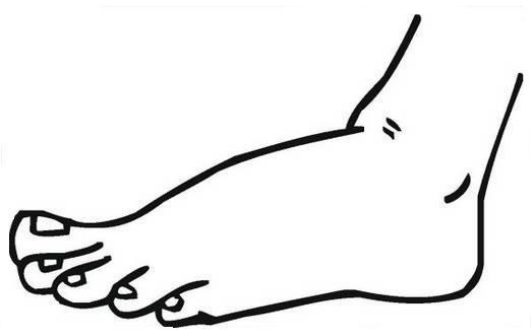

I

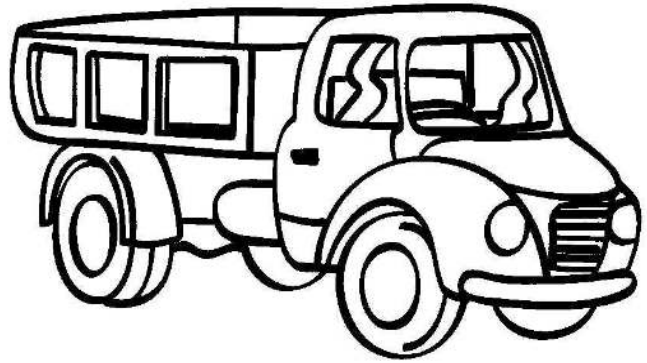
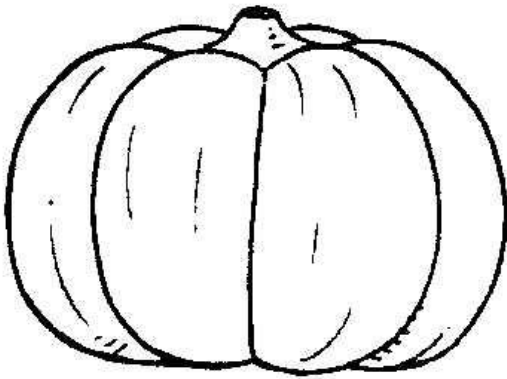

labu

lori

	.....	.....	.....	.....	.....
	.....	.....	.....	.....	.....
.....	.....	.....	.....	.....	.....
.....	.....	.....	.....	.....	.....
.....	.....	.....	.....	.....	.....
.....	.....	.....	.....	.....	.....

Tulis huruf l dalam petak.

l	l					

Tulis huruf awal bagi gambar di bawah.

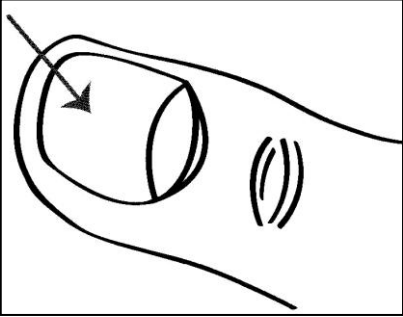

uku

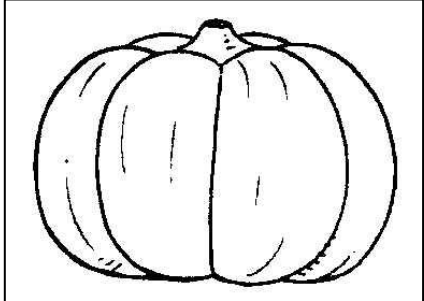

abu





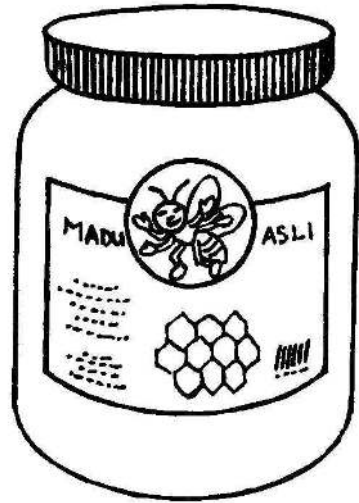
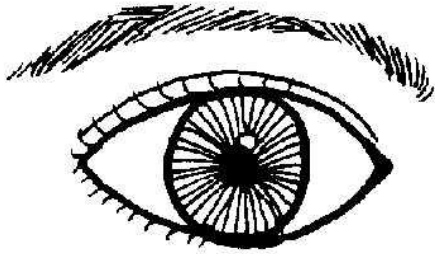





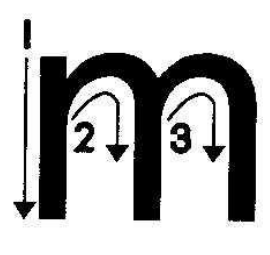
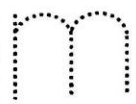



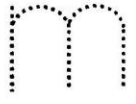
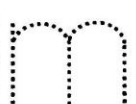
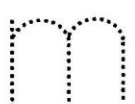
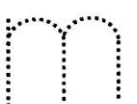
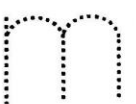
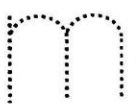
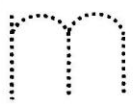



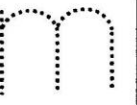

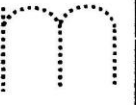

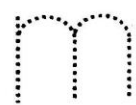
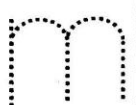
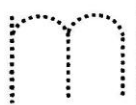

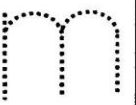
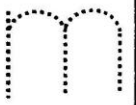

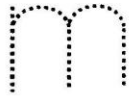
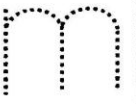

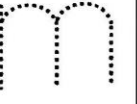
# m

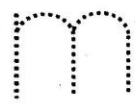
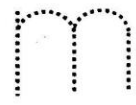

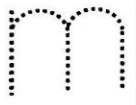
mata

madu

Tulis huruf m dalam petak.

m	m					

Suai gambar dengan perkataan yang betul.

mata

madu

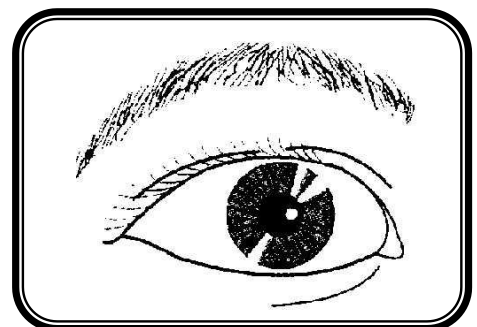
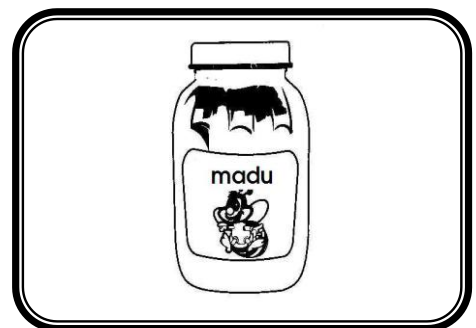



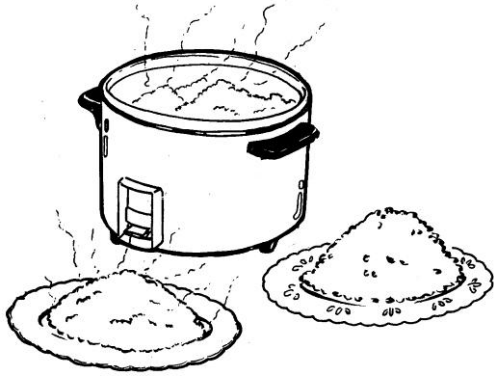





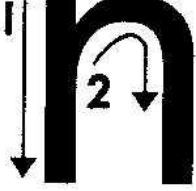
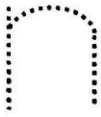
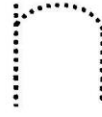
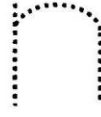
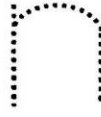

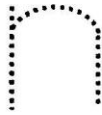



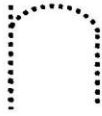



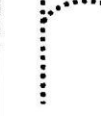

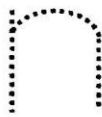

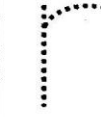
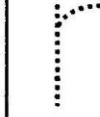

# n

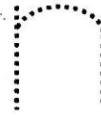
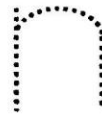

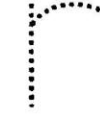
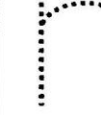
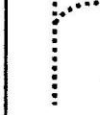
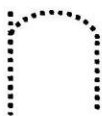
nasi

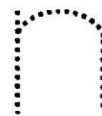
naga

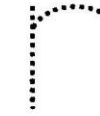
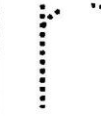
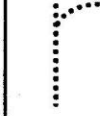

Tulis huruf n dalam petak.

n	n					

Padankan huruf yang sama.

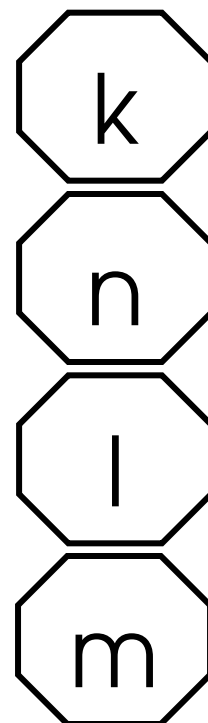
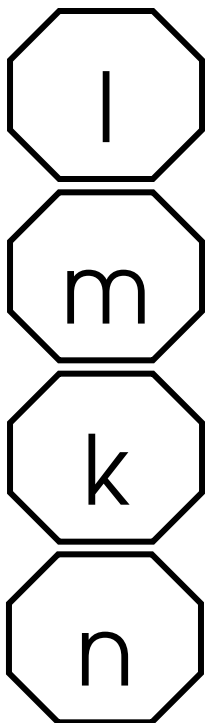

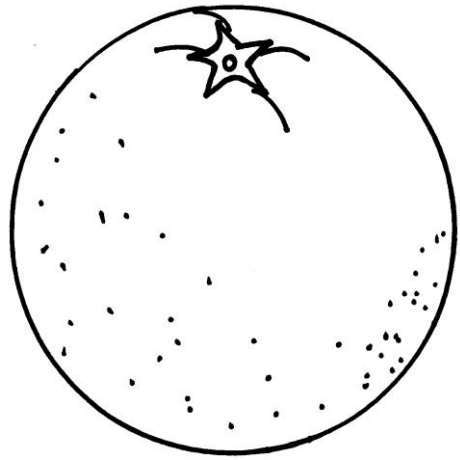
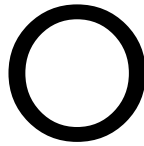

o bor

o ren



Tulis huruf o dalam petak.

o	o					

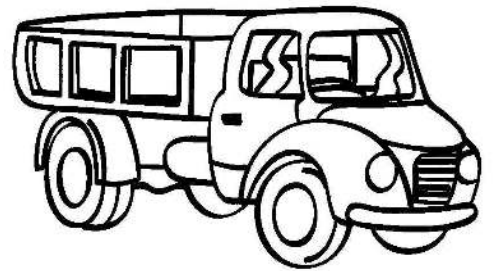
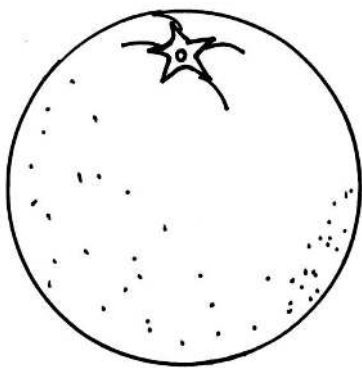
Tulis huruf awal bagi gambar berikut.

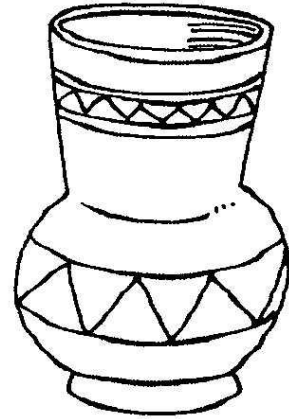
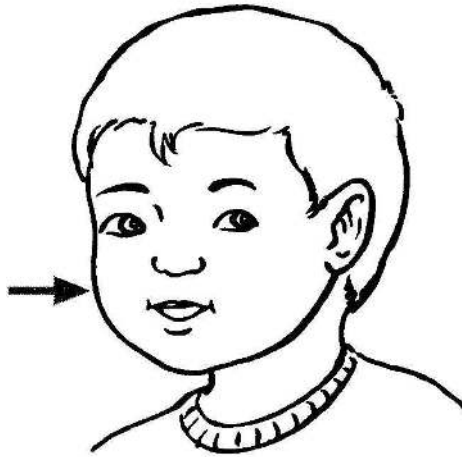

# p



pipi

pasu

Tulis huruf p dalam petak.

p	p					

Tulis huruf awal bagi gambar berikut.

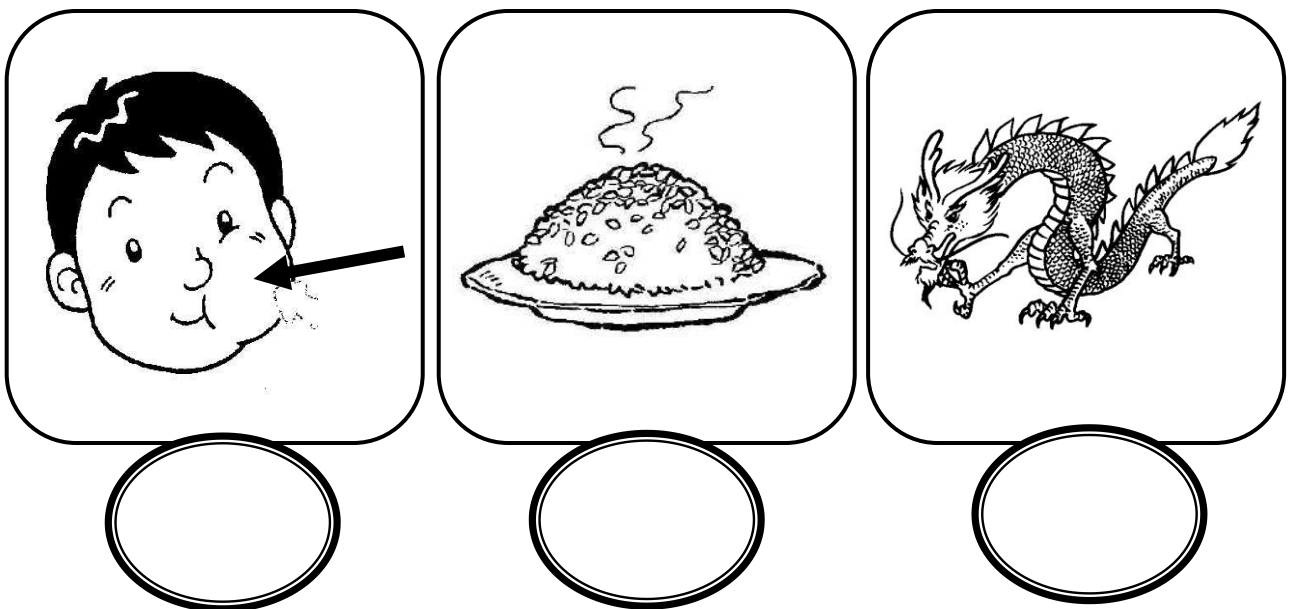









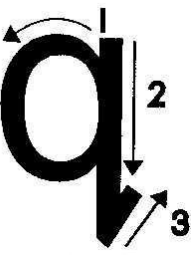
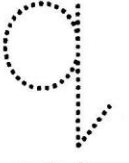
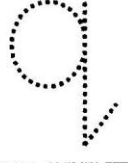

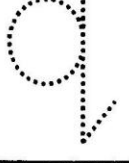

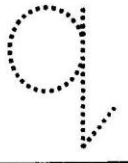

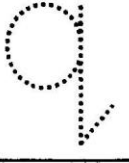

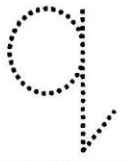

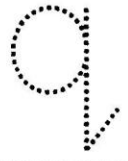

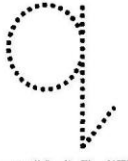

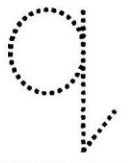
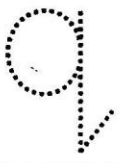
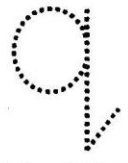

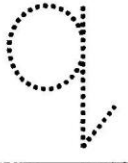
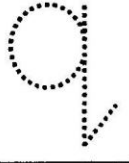

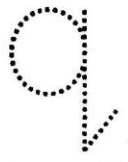

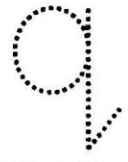

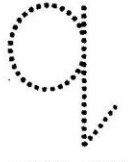
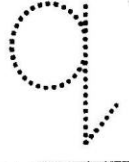
q

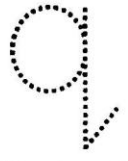

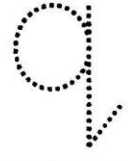
qari

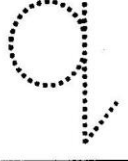
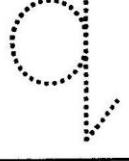
Tulis huruf q dalam petak.

q	q					

Padan huruf awal dengan gambar yang sesuai.

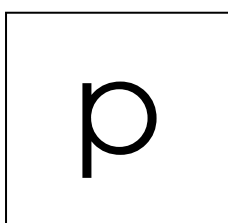
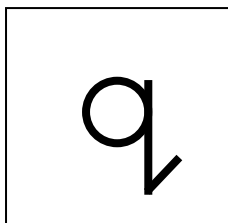

r

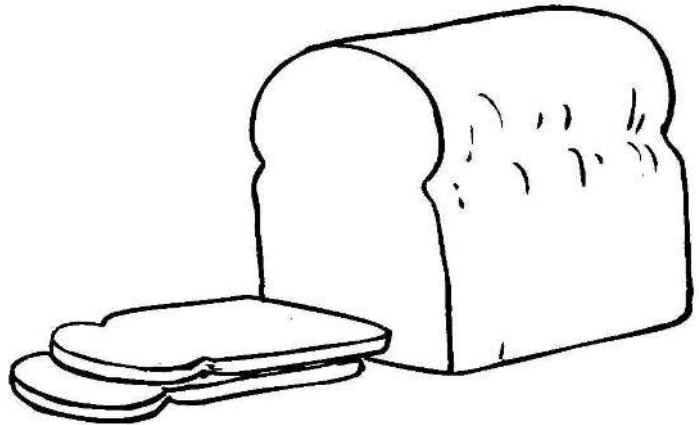

raja

roti



Tulis huruf r dalam petak.

r	r					

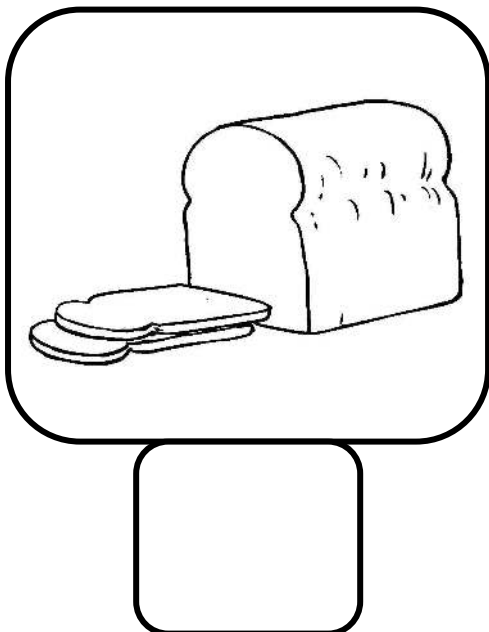
Tulis huruf awal yang sesuai.

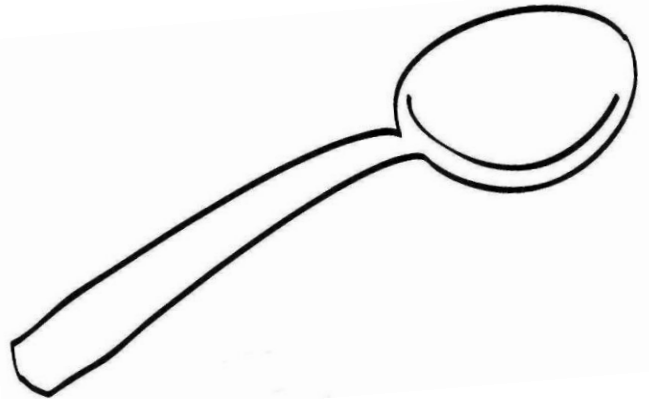

# S



SUSU

SUDU

		S	S	S	S	S
		S	S	S	S	S
S	S	S	S	S	S	S
S	S	S	S	S	S	S
S	S	S	S	S	S	S
S	S	S	S	S	S	S

Tulis huruf s dalam petak.

S	S					

Warna gambar yang bermula dengan huruf s.

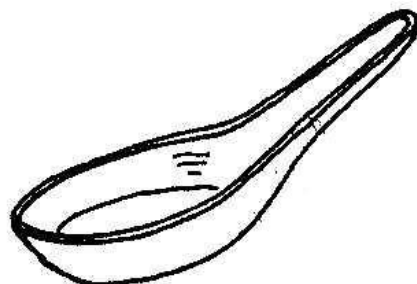
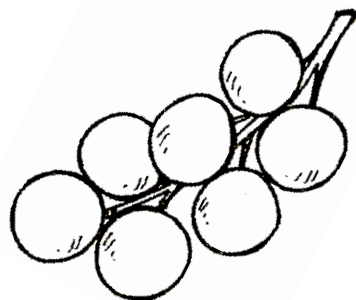
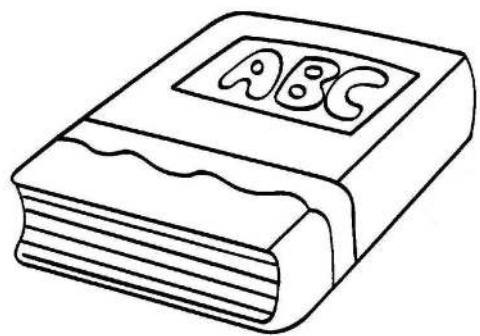



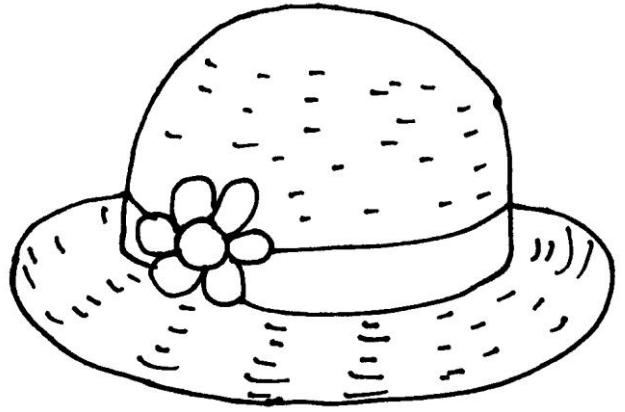
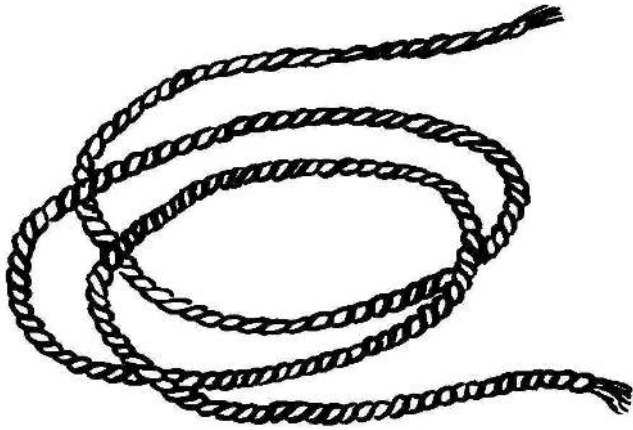



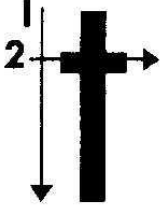
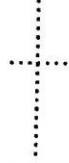

+

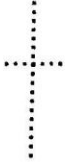

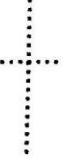
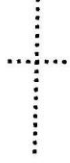
tali

topi

						
						
						
						
						
						



Tulis huruf t dalam petak.

t	t					

Warna huruf awal yang betul berdasarkan gambar .

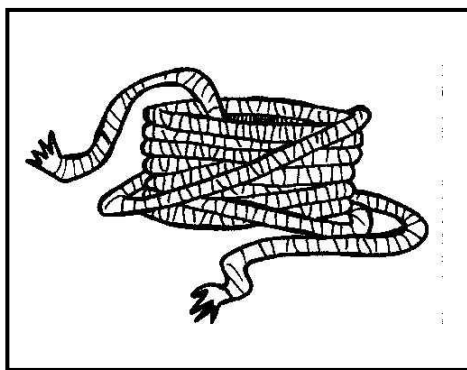

S

t



S

k



# u

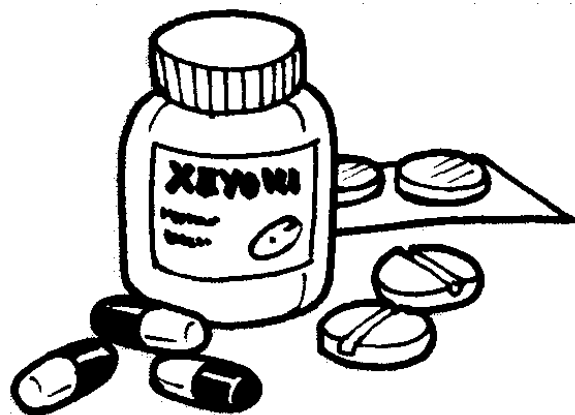
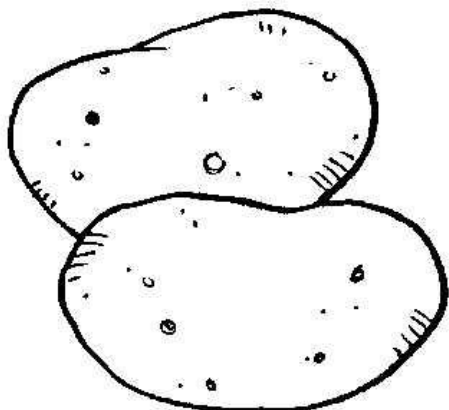

ubi

ubat

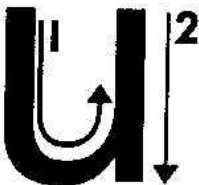
		u	u	u	u	u
		u	u	u	u	u
u	u	u	u	u	u	u
u	u	u	u	u	u	u
u	u	u	u	u	u	u
u	u	u	u	u	u	u

Tulis huruf u dalam petak.

u	u					

Suai perkataan dengan gambar yang sesuai.

ubi



ubat

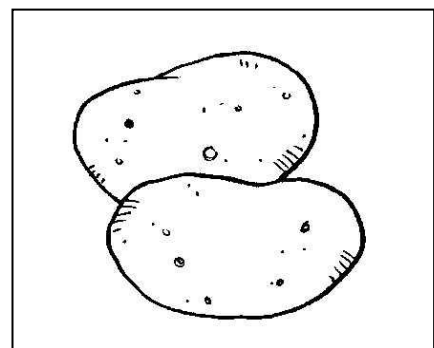



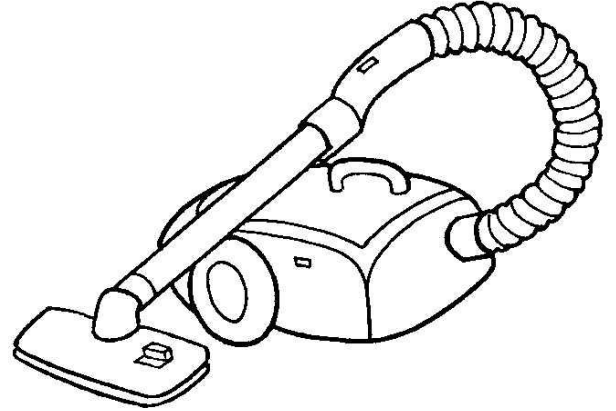
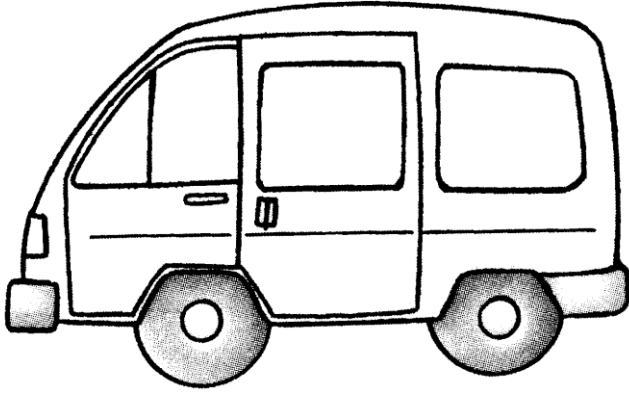





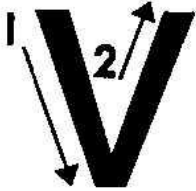





























V



van

vakum

Tulis huruf v dalam petak.

V	V					

Warna perkataan yang betul berdasarkan gambar.

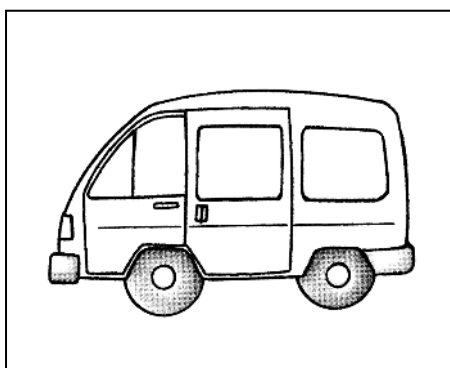

van

topi

ubat

vakum

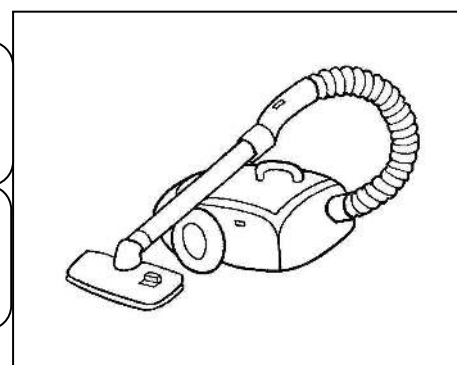









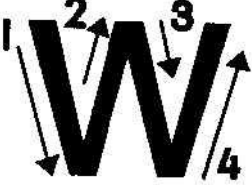

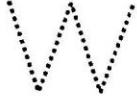





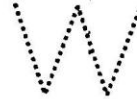







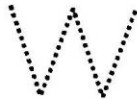













# W



wawa

wira

Tulis huruf w dalam petak.

W	W					

Warna huruf w.



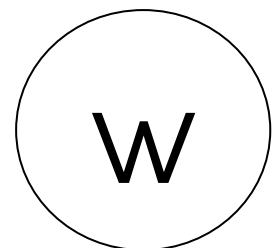
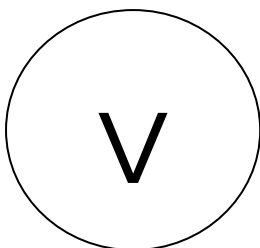
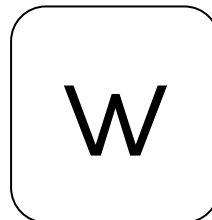
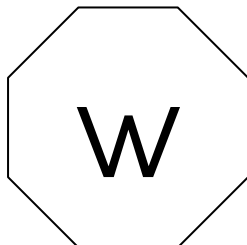
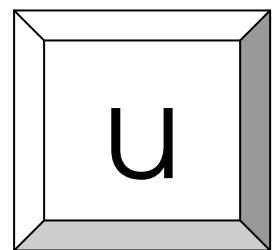
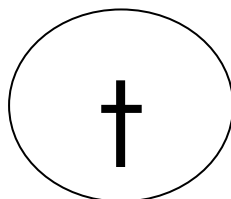
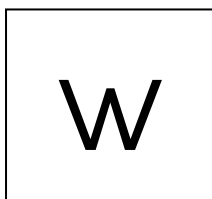

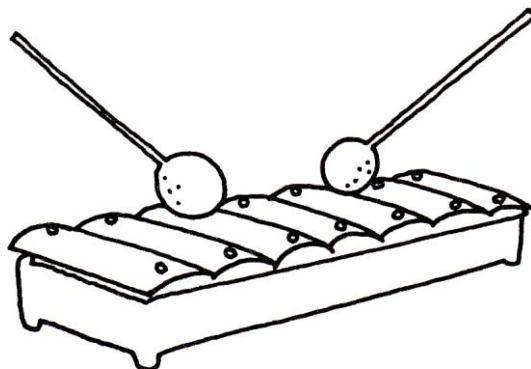





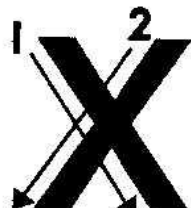





























# X



x-ray

xilofon

						
						
						
						
						
						



Tulis huruf x dalam petak.

X	X					

Tulis huruf yang betul pada tempat kosong.

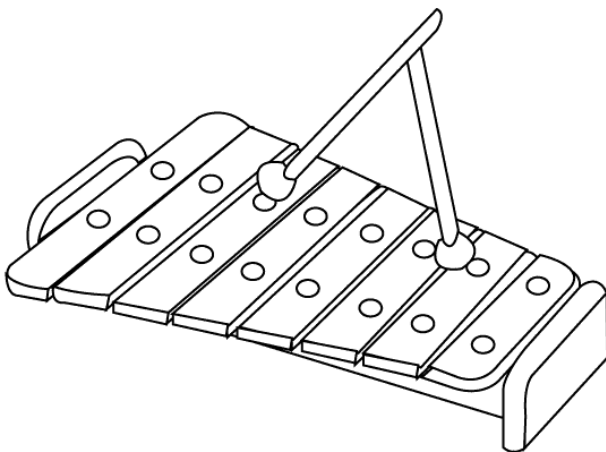

\_\_\_\_\_ ilofon



\_\_\_\_\_ ira





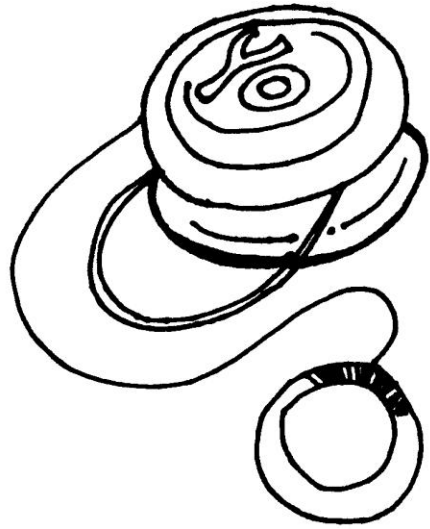
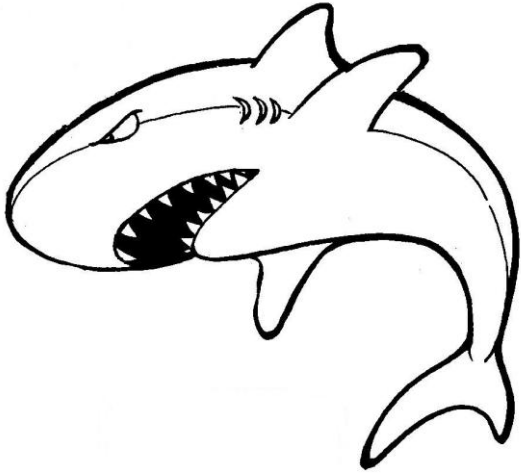





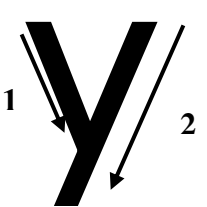































Y



yu

yoyo

Tulis huruf y dalam petak.

y	y					

Padan gambar dengan perkataan yang betul.

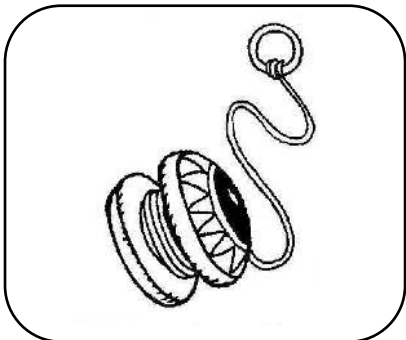
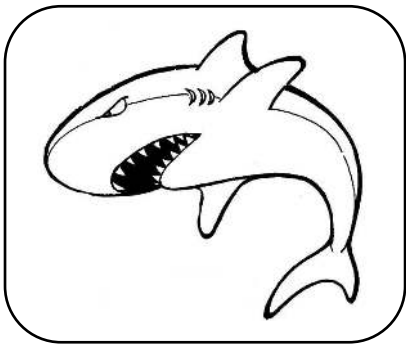

yoyo

wawa





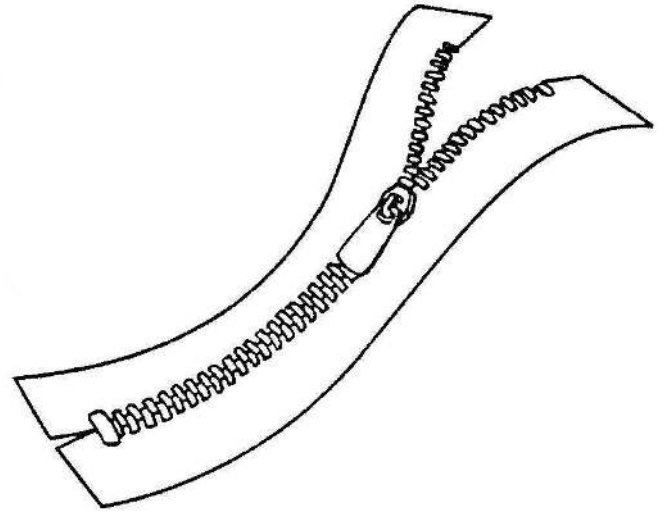
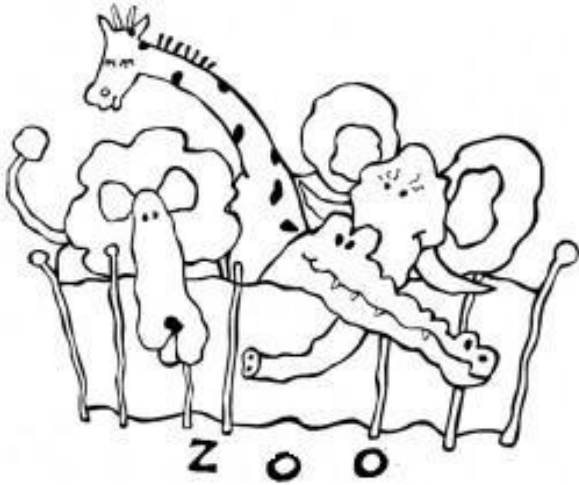



































yu

# Z

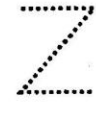
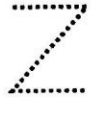

zoo

zip

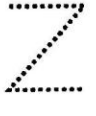
Tulis huruf z dalam petak.

z	z					

Tulis perkataan pada gambar yang diberi.

